

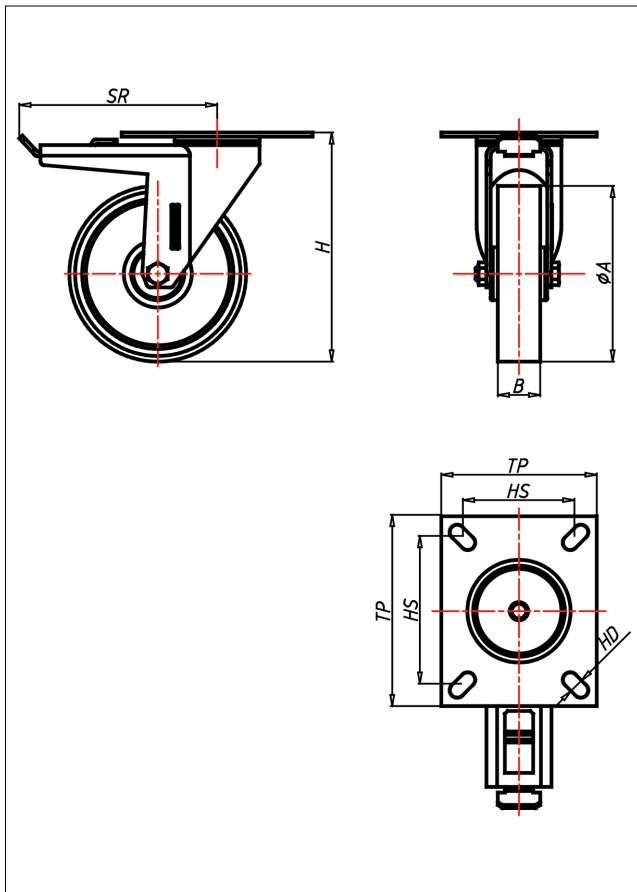

KDT-ALB/AL/ALK

Lenkrolle mit Totalfeststeller



KD-AL



LENKROLLE	LENKROLLE MIT TOTALFESTSTELLER	BOCKROLLE																				
 <ul style="list-style-type: none"> • geringer Rollwiderstand • abrieb- und reißfest • leichte Reinigung • sehr beständig gegen viele aggressive Medien <p>Spritzguss-Polyurethan Felge Polyamid 6 → Seite 253</p> 	 <p>Laufkugeln gehärtet, Kugelbahnen gepresst, starker Zentralzapfen verschraubt - gedichtet - gesichert Staubschutzring, verzinkt → Seite 62</p>	 <p>AUSWAHLHILFE:</p> <table border="1"> <tr> <td>leicht lenkend</td> <td>X</td> <td>+</td> <td>++</td> </tr> <tr> <td>verschleißarm</td> <td>X</td> <td>+</td> <td>++</td> </tr> <tr> <td>stoßfest</td> <td>X</td> <td>+</td> <td>++</td> </tr> <tr> <td>bodenschonend</td> <td>X</td> <td>+</td> <td>++</td> </tr> <tr> <td>witterungsbeständig</td> <td>X</td> <td>+</td> <td>++</td> </tr> </table>	leicht lenkend	X	+	++	verschleißarm	X	+	++	stoßfest	X	+	++	bodenschonend	X	+	++	witterungsbeständig	X	+	++
leicht lenkend	X	+	++																			
verschleißarm	X	+	++																			
stoßfest	X	+	++																			
bodenschonend	X	+	++																			
witterungsbeständig	X	+	++																			

Technische Details

ORDERNO (Artikel-nummer)	KDT 100 ALB
WDAB (Rad-Ø A x Breite B / mm)	100x30
LC (Tragkraft / kg)	160
H (Bauhöhe H / mm)	137
TP (Plattengröße / mm)	105x85
HS (Lochabstand / mm)	80x60
HD (Loch-Ø / mm)	8.5
SR (Schwenkradius / mm)	140
WB (Radlager)	Rollenlager